







BRAUNFELS SMALL, MEDIUM & LARGE LED WALL & BATH

4435793S, 4535793S, 4635793S

General Product Information

 WARRANTY

 FCC STATEMENT

Tools Required

 PHILLIPS-HEAD SCREWDRIVER

Safety Information

CAUTION-RISK OF FIRE

This product must be installed in accordance with the applicable installation code by a person familiar with the construction and operation of the product and the hazards involved.

USE MINIMUM 90°C SUPPLY CONDUCTORS.



Turn off electrical current at the source before working with any lighting fixture or portable lamp.

Install and use this product in adherence with local electrical codes and regulations.



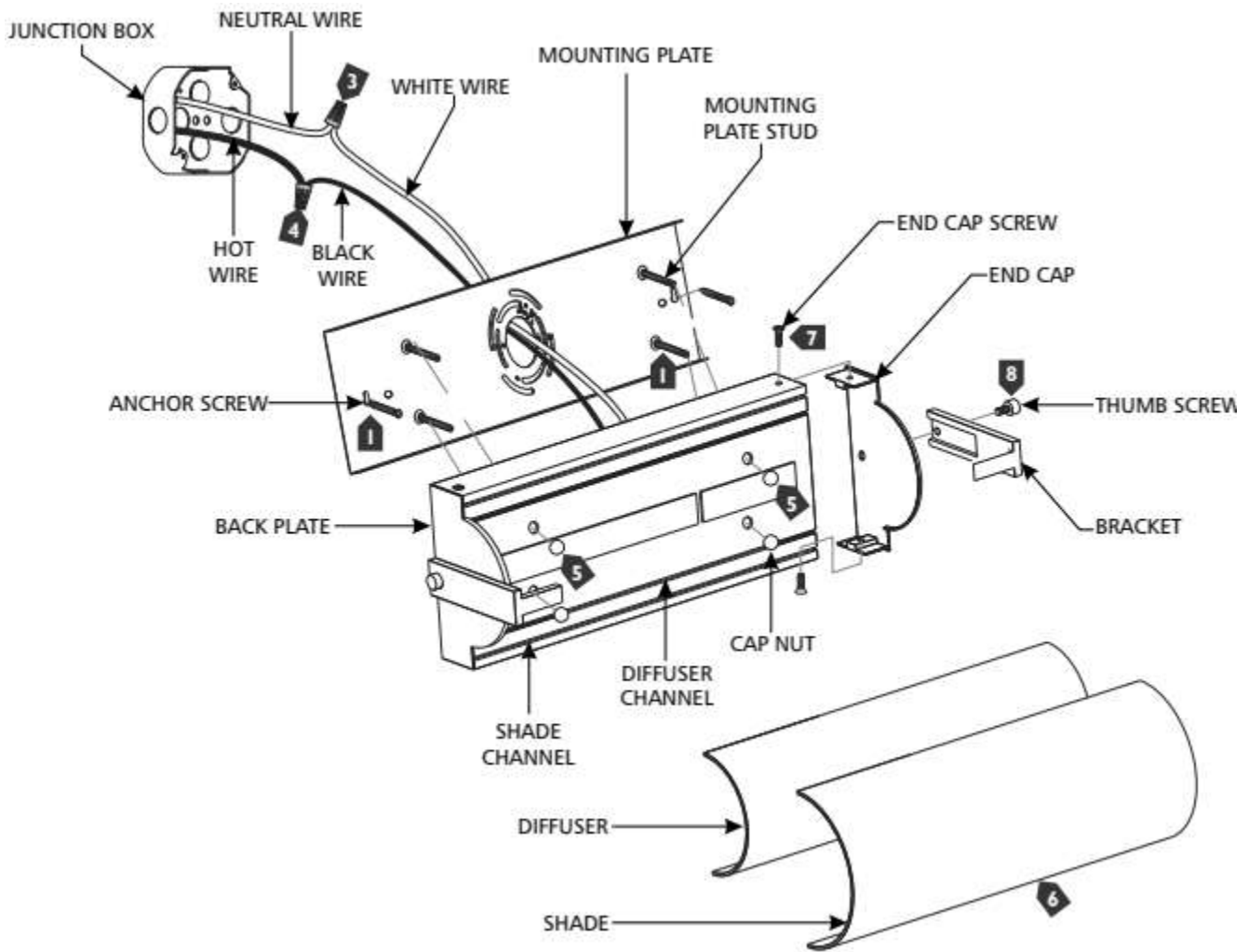

INSTRUCTIONS

I. Preparing the Fixture

1. Secure the mounting plate to the junction box.

II. Wiring the Fixture

1. Safety first! Locate the circuit breaker and switch it off to cut off the power supply to the relevant circuits to ensure there's no electricity running through the wiring.
2. In accordance with local electrical codes, connect the fixture ground wire (bare copper or silver wire) to suitable ground. This may be a green ground screw on the mounting plate, which the ground wire should be tightly wrapped around, or a house wire (green or bare copper wire without insulation).
3. Twist the bare ends of the following pairs of wires together using a wire nut to secure a connection:
 - a) White fixture wire to neutral power line wire
 - b) Black fixture wire to hot power line wire
4. Neatly place the wires into the junction box and/or fixture, then mount the back plate onto the mounting plate studs and secure it with four cap nuts.
5. Slide the diffuser into the diffuser channel, then install the end caps and secure them with two end cap screws.
6. Slide the shade into the shade channel.
7. Install the brackets to the end caps and secure them with two thumb screws.